

Panel doubled with Mylar

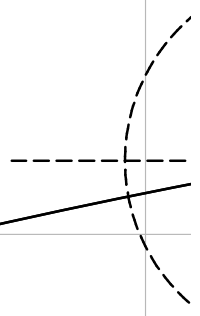

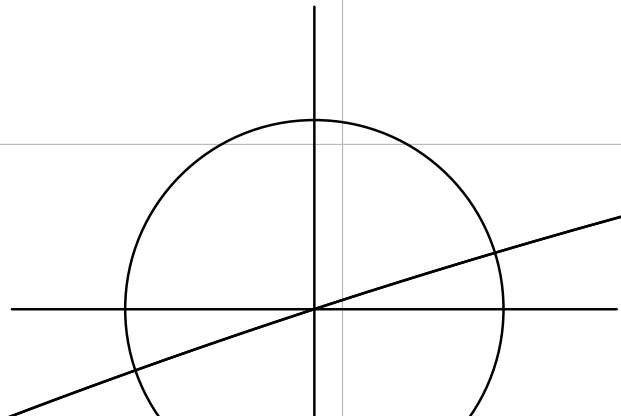

50

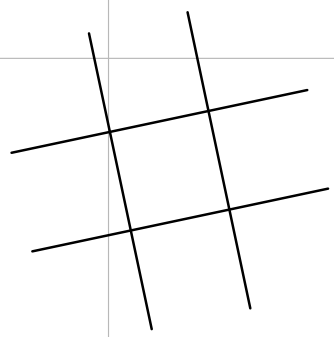
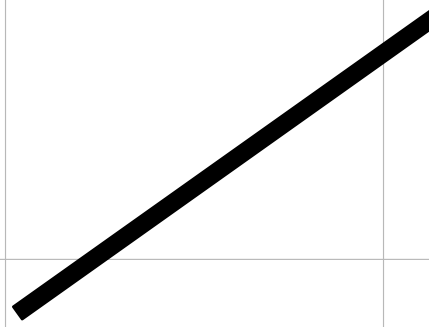
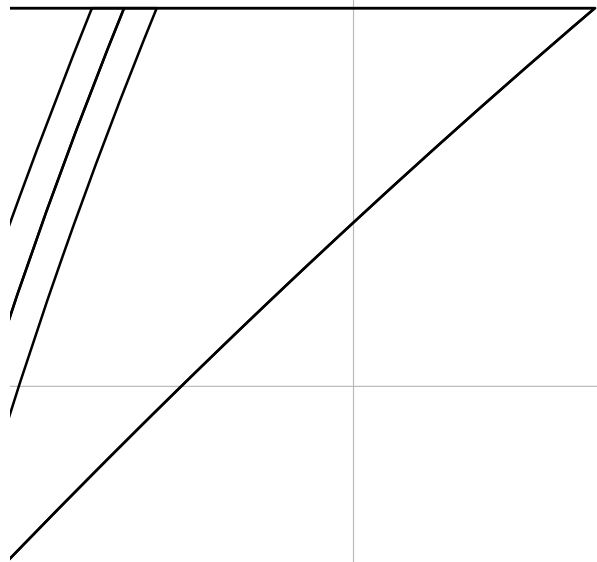
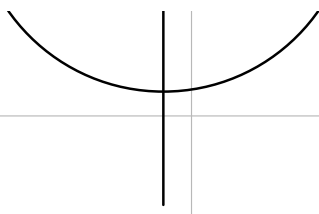
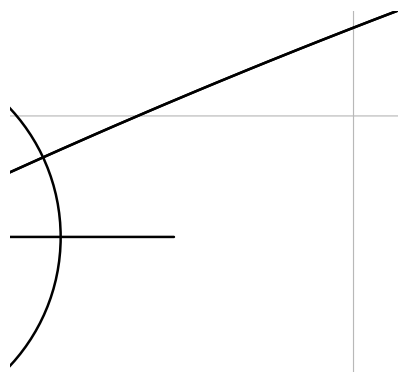
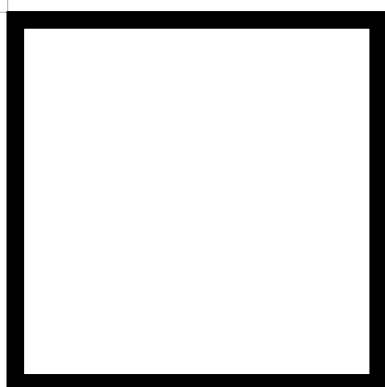

50

VOR'



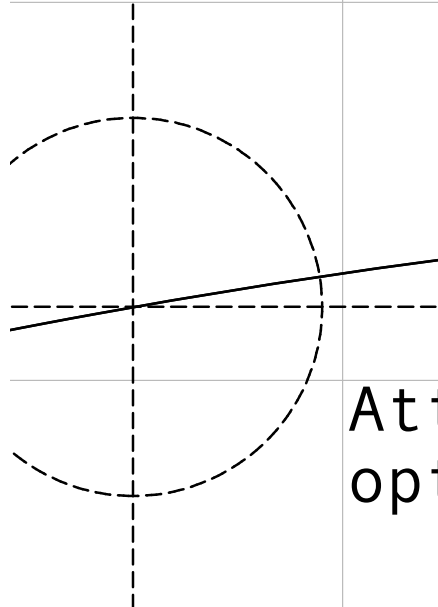
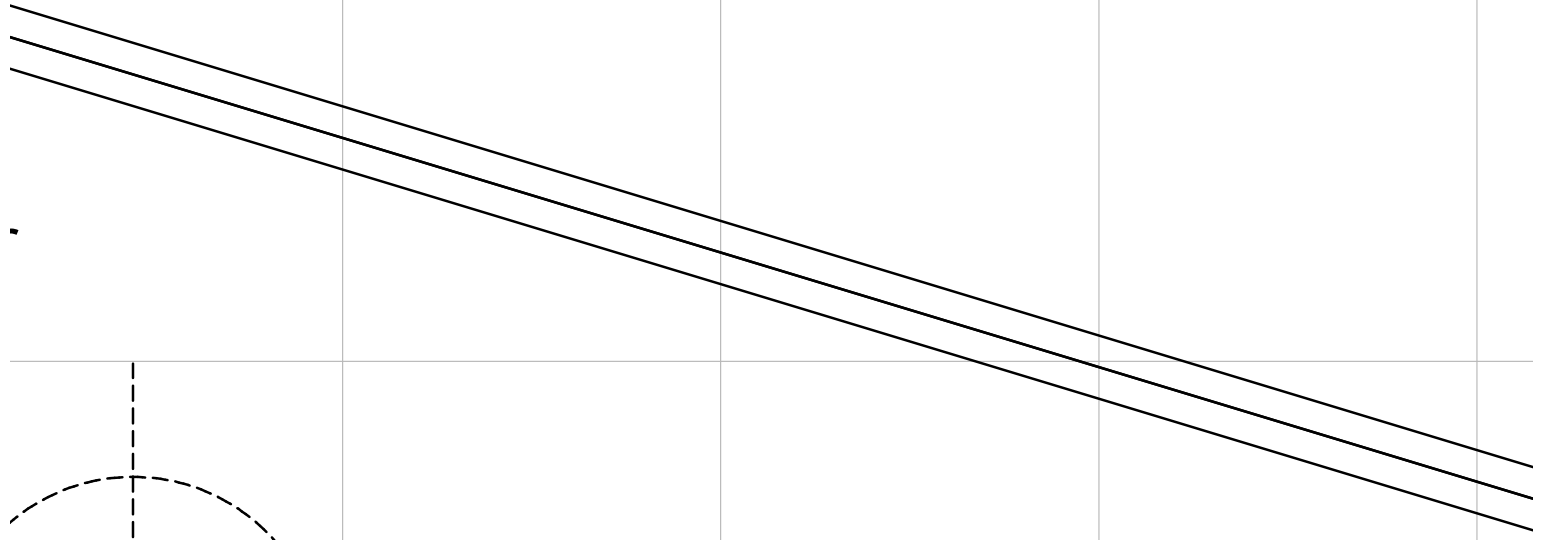
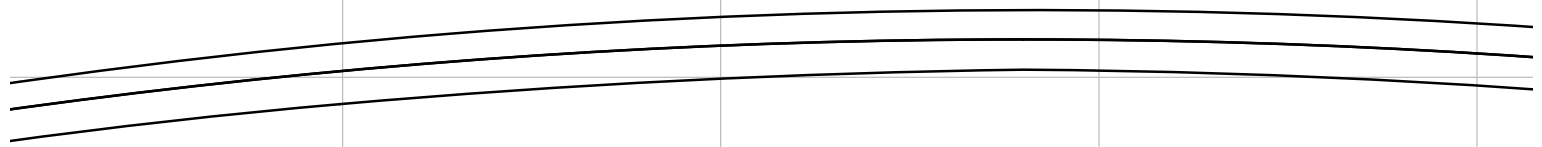
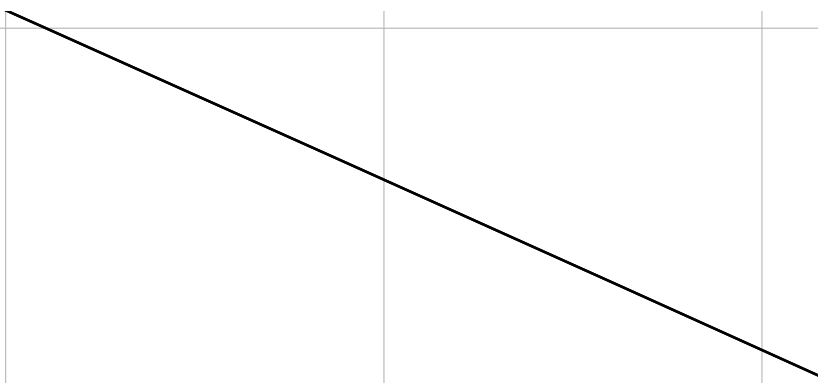
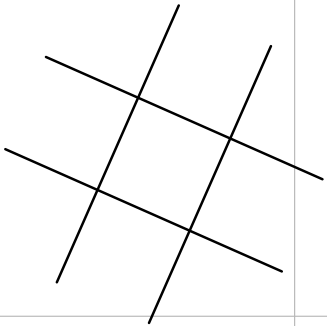

Attachment point for optional Yoyo-ring

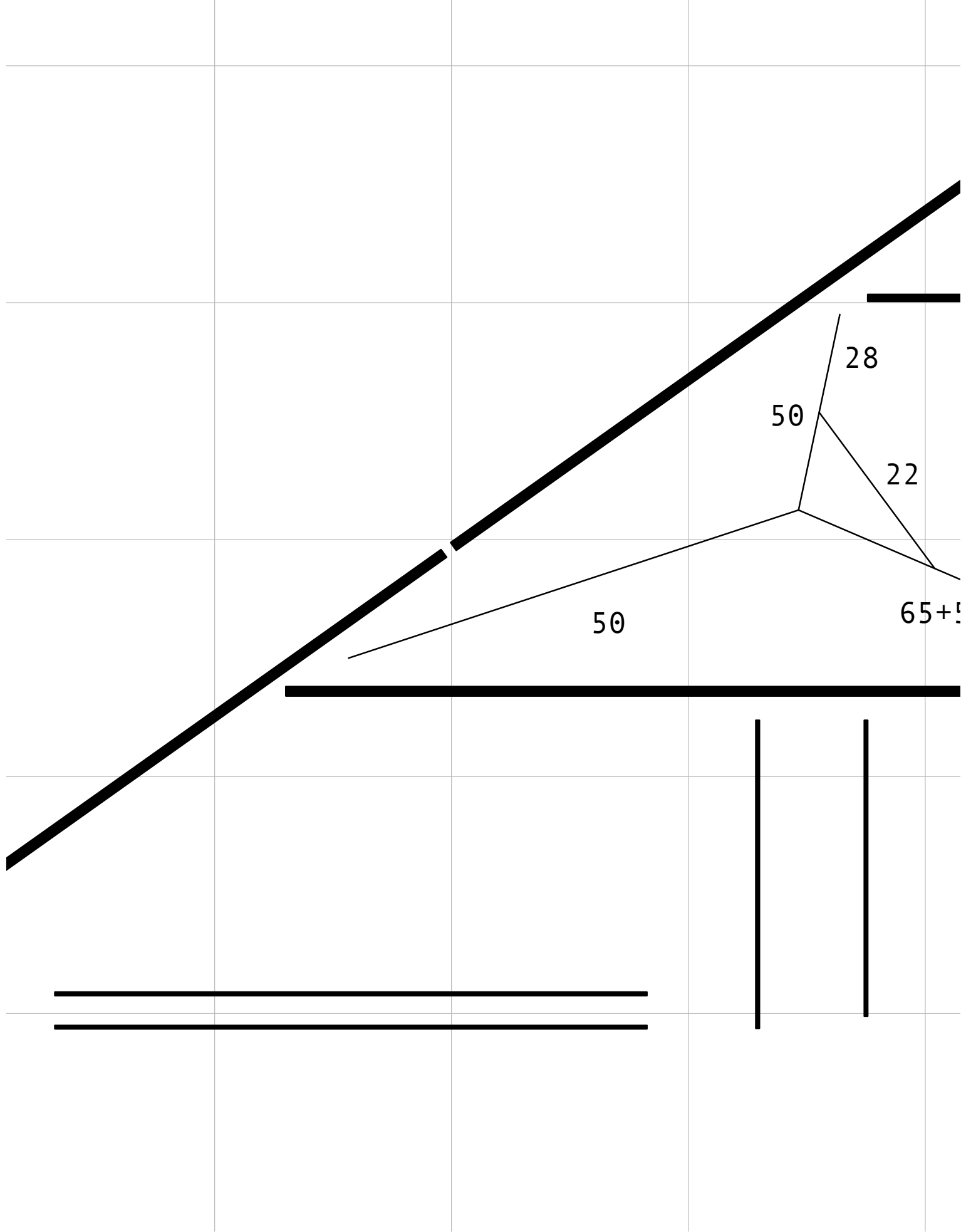

TEX

par Christ-

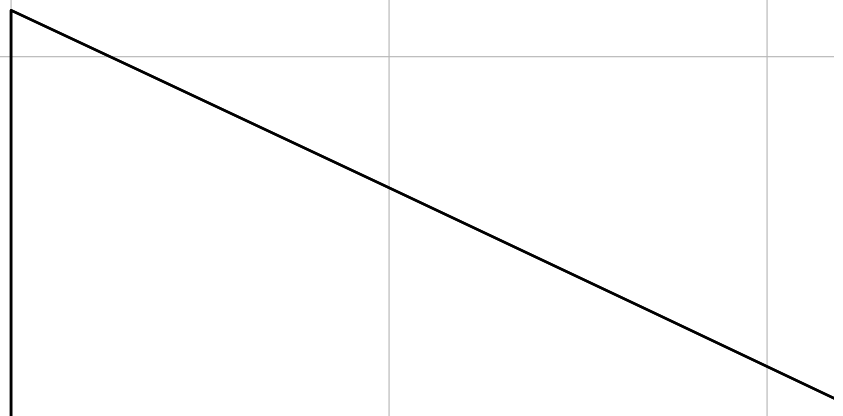
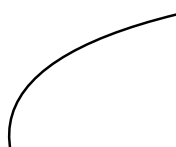
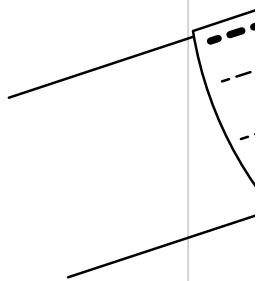

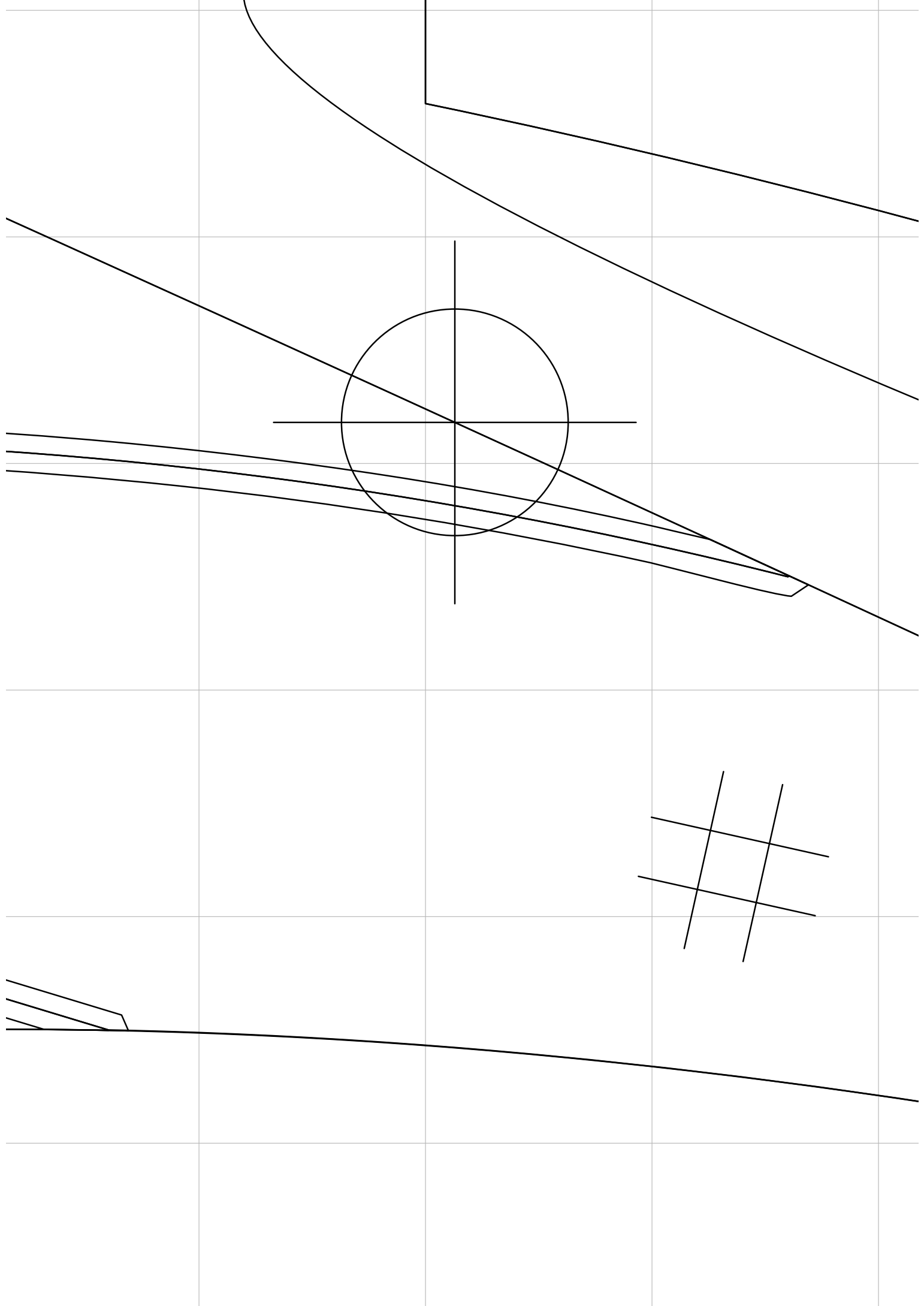

Spar plan 1/4

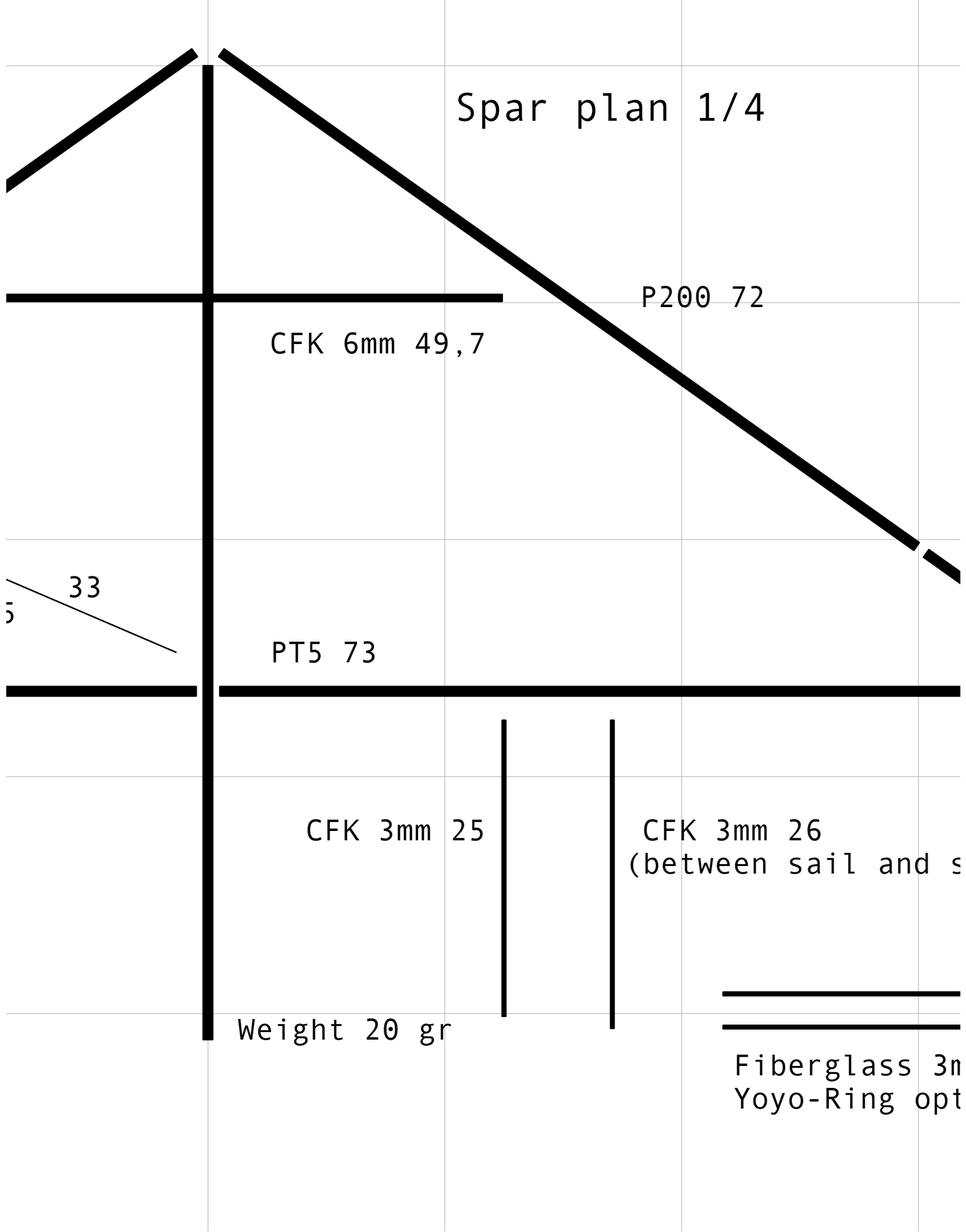

P200 72

CFK 6mm 49,7

33
5

PT5 73

CFK 3mm 25

CFK 3mm 26
(between sail and s

Weight 20 gr

Fiberglass 3m
Yoyo-Ring opt

ian Derefat

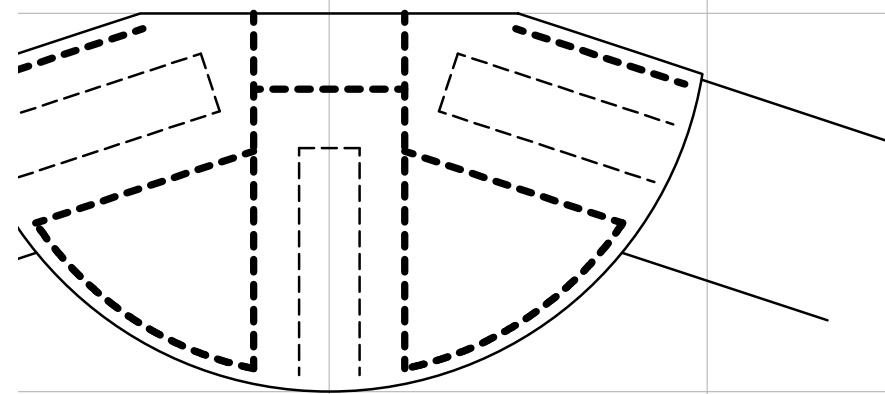

Nose sewing pattern

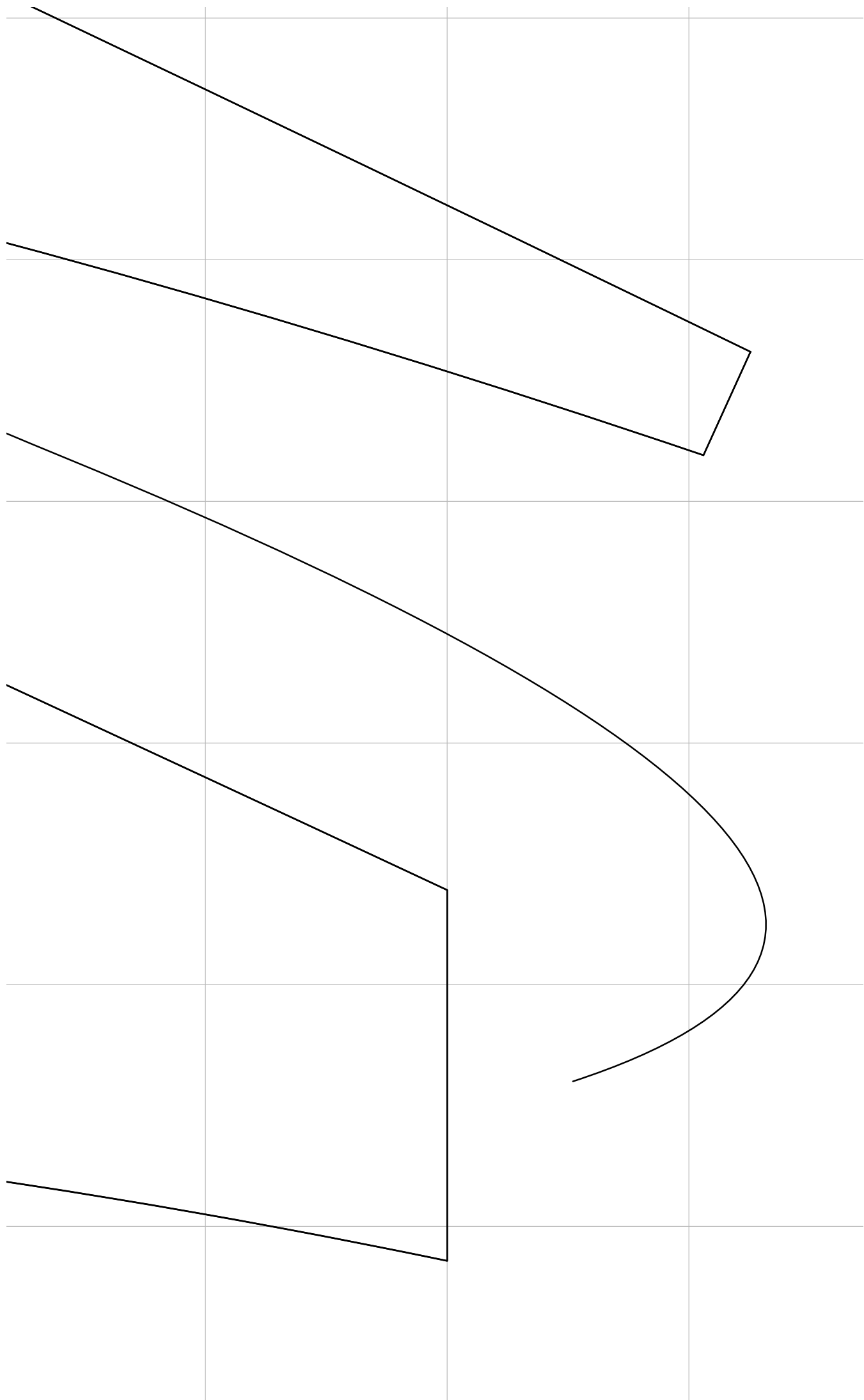

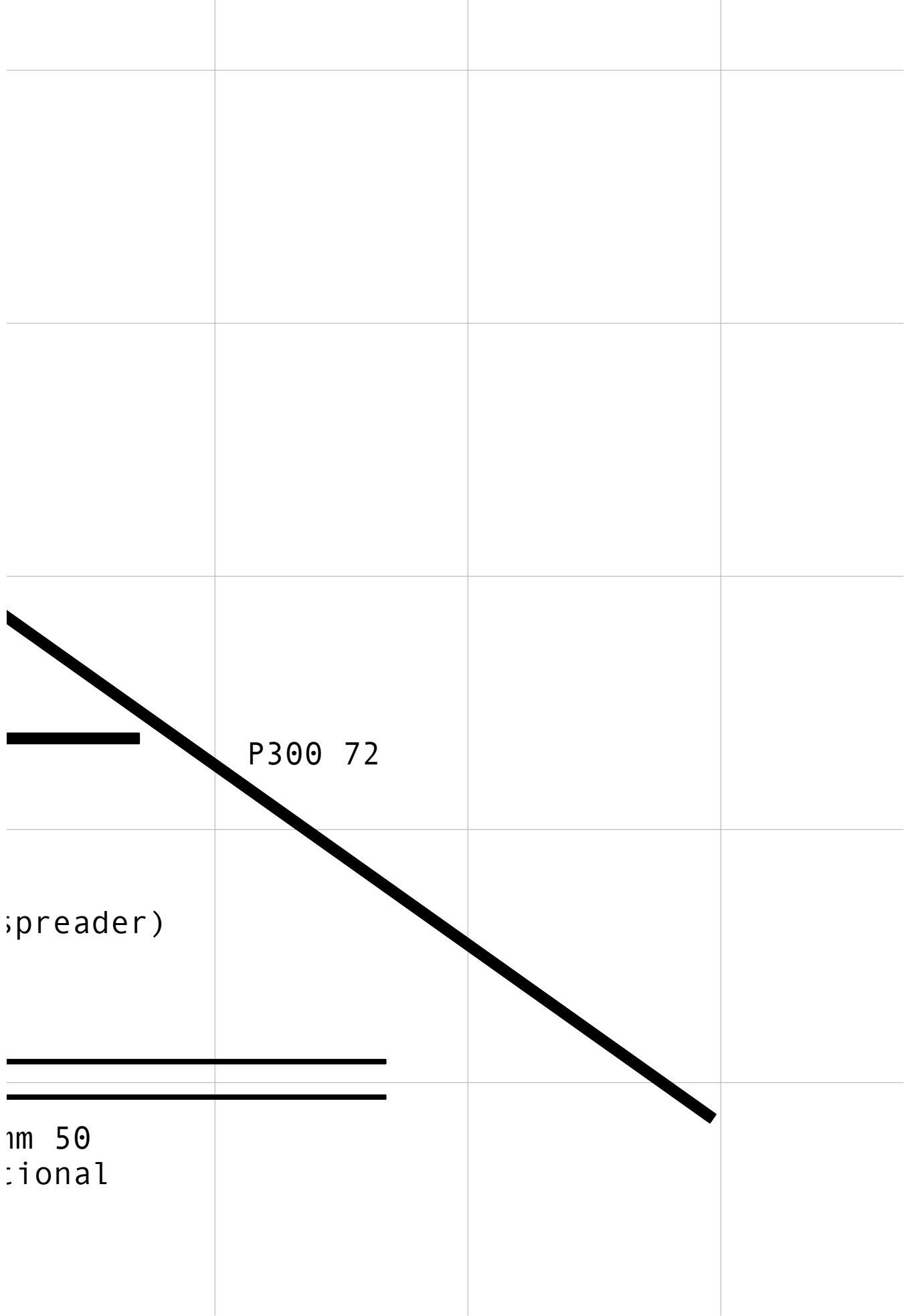

P300 72

spreader)

m 50
ional